

Set for the preparation of composite fillings
Satz zur Bearbeitung von Composite-Füllungen

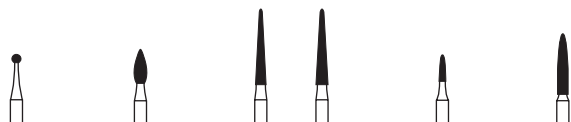

100402



Contents - Inhalt

REF	801C	368C	859C	859C	860C	862C
806.314	001.504	257.504	166.504	166.504	245.504	249.504
	012	016	014	016	009	014
	1	1	1	1	1	1

DTF set of instruments with ultra-fine diamond grit
DTF-Satz in Diamant-Körnung ultrafein



100403



Contents - Inhalt

REF	801U	956U	852U	860LU	862U	368AU	368U	379U	827U	392U
806.314	001.494	159.494	164.494	247.494	249.494	254.494	257.494	277.494	464.494	465.494
	012	009	010	010	012	016	016	016	018	014
	1	1	1	1	1	1	1	1	1	1

DTF set of instruments with extra-fine diamond grit
DTF-Satz in Diamant-Körnung extrafein



100404



Contents - Inhalt

REF	801C	956C	852C	860LC	862C	368AU	368U	379U	827U	392U
806.314	001.504	159.504	164.504	247.504	249.504	254.504	257.504	277.504	464.504	465.504
	012	009	010	010	012	016	016	016	018	014
	1	1	1	1	1	1	1	1	1	1



**DTF set DUAL of instruments
with extra-fine / ultra-fine diamond grit**

*DTF-Satz DUAL
in Diamant-Körnung extrafein / ultrafein*

100405

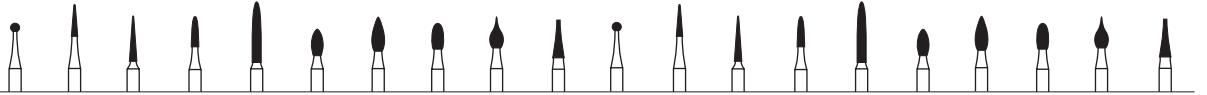

Contents - Inhalt

REF	801C	956C	852C	860LC	862C	368AC	368C	379C	827C	392C	801U	956U	852U	860LU	862U	368AU	368U	379U	827U	392U	
ISO	806.314	001.504	159.504	164.504	247.504	249.504	254.504	257.504	277.504	464.504	465.504	001.494	159.494	164.494	247.494	249.494	254.494	257.494	277.494	464.494	465.494
		012	009	010	010	012	016	016	016	018	014	012	009	010	010	012	016	016	016	018	014
		1	1	1	1	1	1	1	1	1	1	1	1	1	1	1	1	1	1	1	1



Therapie Set

Therapie Satz

100423

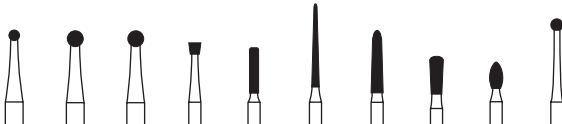

Contents - Inhalt

REF	CB1S	CB1S	801	805	836KR	859	868	830L	368A	801LG	
ISO	806.204/314	001.003	001.003	001.524	010.524	157.524	167.524	223.524	234.524	254.524	697.534
		014	021	012	016	012	010	016	018	018	016
		1	1	1	1	1	1	1	1	1	1



Crown Preparation Set

Kronenpräparations-Satz

100424

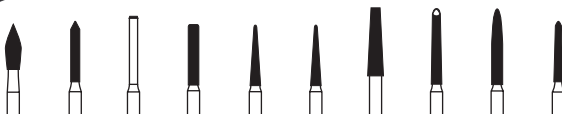

Contents - Inhalt

REF	899F	885	839	837KR	858	859F	848	857	863	878	
ISO	806.314	033.514	130.524	150.524	158.524	165.524	166.514	173.524	220.524	250.524	289.524
		021	012	012	014	014	014	021	014	016	012
		1	1	1	1	1	1	1	1	1	1



Crown & Veneer Preparation Kit

Crown & Veneer Präparation Kit

100425

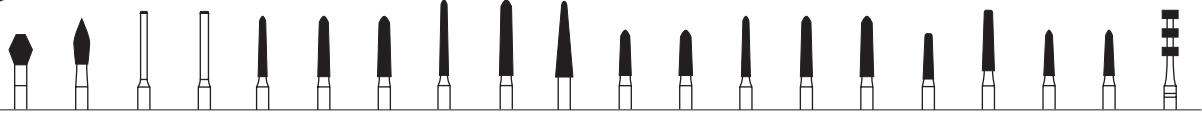

Contents - Inhalt

REF	811	899	839A	839A	878K	878K	878K	879K	879K	859	877K	877K	878K	878K	878K	846KR	847KR	878K	877K	834
ISO	806.314/313	038.524	033.524	-	298.524	298.524	298.524	299.524	299.524	-	297.524	297.524	298.524	298.524	298.524	545.524	546.524	298.524	297.524	552.524
		031	021	010	012	016	018	016	018	023	016	018	012	016	018	014	016	014	014	021
			1	1	1	1	1	1	1	1	1	1	1	1	1	1	1	1	1	1



Crown Preparation Kit by Dr. Woo

Kronenpräparationssatz nach Dr. Woo

100426

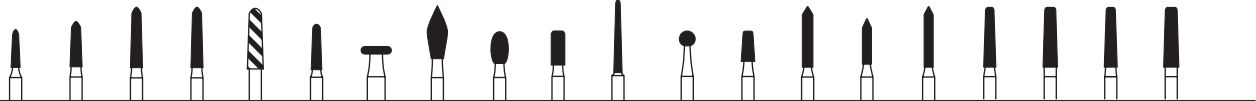

Contents - Inhalt

REF	876KG	877KG	878KG	878KF	I856SG	855	909G	899	379	835KR	850SMF	801G	845KR	885G	884G	885F	951KR	951KR	951KRF	951KRF	
ISO	806.314	296.534	297.534	298.534	298.514	-	197.524	068.534	033.524	277.524	156.524	199.xxx	001.534	544.524	130.534	129.534	130.514	-	-	-	-
		012	016	016	016	021	014	040	027	023	018	011	021	018	014	012	012	016	019	017	020
		1	1	1	1	1	1	1	1	1	1	1	1	1	1	1	1	1	1	1	1

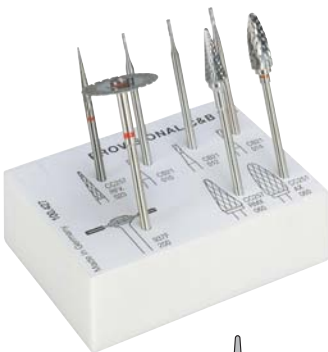

Provisional C & B Kit

Provisional C & B Satz

100427

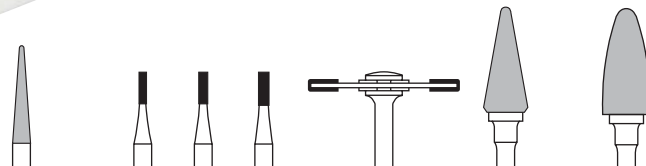

Contents - Inhalt

REF	CC257RFX	CB21	CB21	CB21	937F	CC257RMX	CC 251AX
ISO	806.104	201.140	107.006	107.006	107.006	-	201.190
		023	010	012	014	200	060
		1	1	1	1	1	1

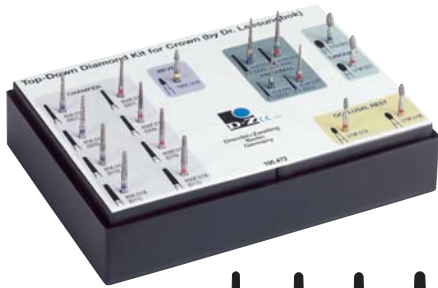

**Top-Down Diamond Kit for Crown
by Dr. Leesungbok**

*Top-Down Diamond Kit for Crown
nach Dr. Leesungbok*

100472

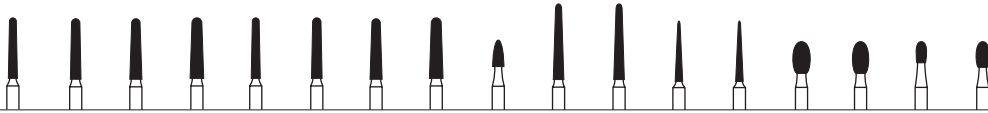

Contents - Inhalt

REF	856	856	856	856	856F	856F	856F	856F	390C	850	850F	858	858F	379	379F	379F	379F
ISO	198.524	198.524	198.524	198.524	198.514	198.514	198.514	198.514	274.504	199.524	199.514	165.524	165.504	277.524	277.514	277.514	277.514
	012(007)	014(009)	016(010)	018(011)	012(007)	014(009)	016(010)	018(011)	016	014(006)	014(006)	010(005)	010(005)	023	021	014	018
	1	1	1	1	1	1	1	1	1	1	1	1	1	1	1	1	1

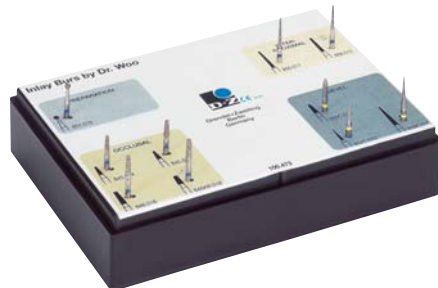

Inlay Burs by Dr. Woo

Inlay Burs nach Dr. Woo

100473



Contents - Inhalt

REF	801	845	845	846	846KR	850	868	860C	852C	859C	
ISO	806.314	001.524	168.524	168.524	171.524	545.524	199.514	223.524	245.504	164.504	166.504
		016	014	016	016	018	011	012	015	010	016
	1	1	1	1	1	1	1	1	1	1	1



ABB 15

REF	ABB 15
------------	--------



ABB 30

REF	ABB 30
------------	--------